

0 611 205 103; 803

Issue } 03-10-16 **Fig./Abb. 2**
Stand }

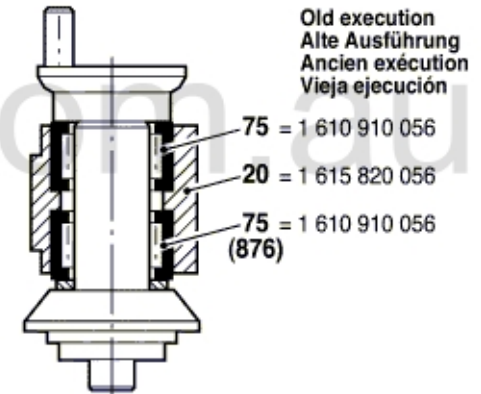
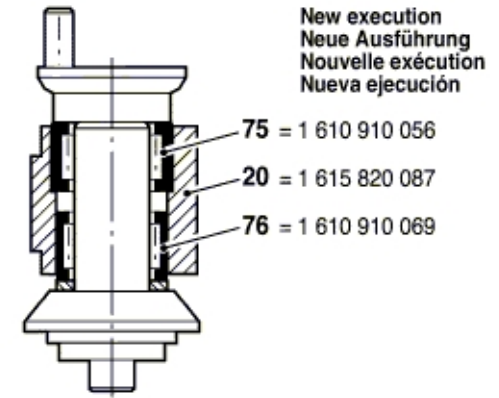
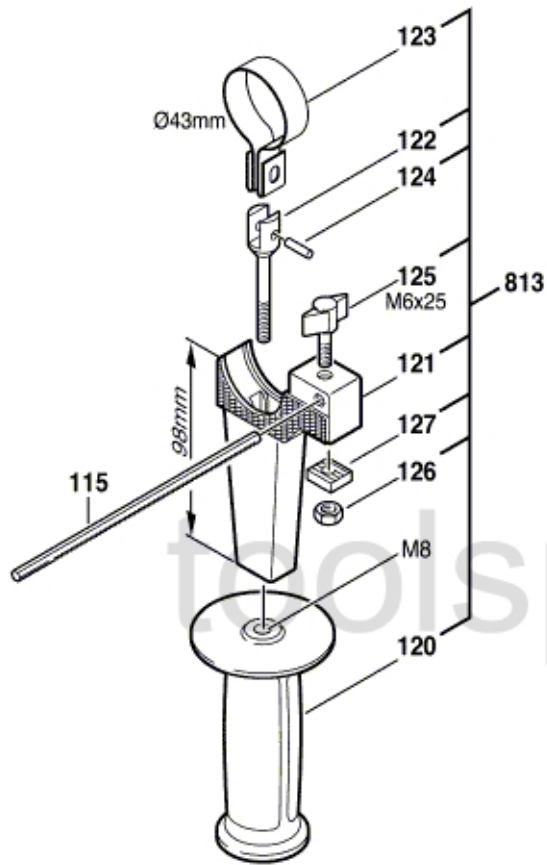

Modifications reserved
Änderungen vorbehalten
Modifications réservées
Salvo modificaciones